



**ECONOFLAME R30  
GAS FIRED WALL MOUNTED  
CONDENSING BOILERS**

INSTALLATION, OPERATION & MAINTENANCE  
DOCUMENTATION

**STOKVIS ENERGY SYSTEMS**  
96R WALTON ROAD  
EAST MOLESEY  
SURREY  
KT8 0DL  
TEL: 020 8783 3050 / 08707 707 747  
FAX: 020 8783 3051 / 08707 707 767  
E-MAIL: [info@stokvisboilers.com](mailto:info@stokvisboilers.com)  
WEBSITE: [www.stokvisboilers.com](http://www.stokvisboilers.com)

DOC653/30CV02A 151204

---

Edition 30CV02A, 18-11-2004

© 2004 Rendamax B.V.  
All rights reserved.

No part of this publication may be copied and/or published by means of printing, photocopying, microfilming, or by electronic means, on tape or in any other manner whatsoever without the prior permission of Rendamax B.V. in writing.

We are engaged in a constant effort to improve our products. As a result of this process, the products may deviate slightly from the descriptions contained in the present document. Rendamax B.V. accepts no liability whatsoever for differences between the products delivered and the information contained in the present document.

**Doc653/30CV02A**

# Table of contents

<b>R30 Technical data</b>	<b>1</b>
<b>Dimensions R30</b>	<b>2</b>
<b>1 Introduction</b>	<b>3</b>
1.1 Stokvis	
1.2 The supplier	
1.3 This document	
1.4 Service	
1.5 General restrictions	4
<b>2 Description</b>	
2.1 General	
2.2 Main components	6
2.2.1 Description of principal components	
2.3 Boiler control	7
2.4 Safety aspects	8
<b>3 Safety</b>	
<b>4 Delivery and transport</b>	<b>9</b>
4.1 Delivery	
4.2 Packaging	10
4.3 Transport	
<b>5 Installation</b>	
5.1 Regulations	
5.2 Installation area	
5.2.1 General	
5.2.2 Installation	
5.2.3 Ventilation	11
5.3 Connections	
5.3.1 Gas connection	
5.3.2 Electrical connections	
5.3.3 Water connections	14
5.3.4 Flue gas outlet and air inlet	
5.3.4.1 Connection possibilities	
5.3.4.2 Air inlet pipe	15
5.3.4.3 Flue gas outlet	
5.3.4.4 Flue	16
5.3.5 Condensate drain	18
5.4 Hydraulic system	
5.4.1 Water flow	
5.4.1.1 Flow and resistance	
5.4.1.2 Pump characteristics	19
5.4.1.3 Shut-off valves	
5.4.1.4 Valves	
5.4.1.5 Water flow protection device	
5.4.2 Water pressure	20
5.4.2.1 Operating pressure	
5.4.2.2 Boiler expansion vessel	
5.4.2.3 System expansion vessel	
5.4.2.4 Water pressure protection device	

5.4.3	Water temperature	20
5.4.4	Water quality	
<b>6</b>	<b><i>Operating instructions</i></b>	<b>21</b>
6.1	Operation	
6.2	Controls	
6.3	Boiler module KM628	22
6.4	Fault signals	23
6.5	Setting into operation	25
6.6	Switching-off the appliance	
6.7	Warnings	
<b>7</b>	<b><i>Commissioning</i></b>	
7.1	General	
7.2	Commissioning	26
<b>8</b>	<b><i>Maintenance</i></b>	<b>27</b>
8.1	Safety	
8.2	General	
8.3	Procedure	28
8.4	Cleaning the burner and the heat exchanger	
8.5	Cleaning the strainer of the gas combination block	
8.6	Ionisation measurement	
8.7	Service	
<b>9</b>	<b><i>Conversion formulae and factors</i></b>	<b>29</b>

## R30 Technical data

Type		R30/45	R30/65	R30/85	R30/100	R30/120
Nominal heat output (80/60°C)	kW	5.6-39.2	8.3-59.2	15.6-77.8	17.6-88.2	21.9-109.8
Nominal heat output (40/30°C)	kW	6.3-43.0	9.2-65.0	17.0-85.0	19.2-96.3	24.0-120.0
Heat input, gcv (H <sub>s</sub> )	kW	6.4-44.4	9.5-67.4	17.7-88.8	19.9-99.9	25.0-124.8
Heat input, ncv (H <sub>i</sub> )	kW	5.8-40.0	8.6-60.7	16.0-80.0	18.0-90.0	22.5-112.4
Gas consumption Natural gas H (10.9 kWh/m <sup>3</sup> )	m <sup>3</sup> /h	0.5-3.7	0.8-5.6	1.4-7.3	1.6-8.2	2.1-10.3
Propane (24.65 kWh/m <sup>3</sup> )	m <sup>3</sup> /h	0.2-1.6	0.3-2.5	0.6-3.2	0.7-3.6	0.9-4.6
Gas inlet pressure Natural gas (min./max.)	mbar	17/20	17/20	17/20	17/20	17/20
Propane (min./max.)	mbar	30/50	30/50	30/50	30/50	30/50
Maximum water temperature of central heating system	°C	90	90	90	90	90
Maximum operating pressure	bar	6	6	6	6	6
Water content	litre	5.1	6.6	8.4	10.3	12.0
Water resistance (ΔT= 20°C)	kPa	14	20	25	28	30
Excess head of the boiler pump (ΔT= 20°C)	kPa	26	29	15	24	12
Connection for flue outlet	D mm	80	80	100	100	100
Connection for air inlet	D1 mm	80	80	100	100	100
Gas connection	G	R <sup>3</sup> / <sub>4</sub> "	R <sup>3</sup> / <sub>4</sub> "	R <sup>3</sup> / <sub>4</sub> "	R <sup>3</sup> / <sub>4</sub> "	R <sup>3</sup> / <sub>4</sub> "
Water connection	W (int)	Rp1"	Rp1"	Rp1"	Rp1"	Rp1"
	W (ext)	R1 <sup>1</sup> / <sub>4</sub> "	R1 <sup>1</sup> / <sub>4</sub> "	R1 <sup>1</sup> / <sub>4</sub> "	R1 <sup>1</sup> / <sub>4</sub> "	R1 <sup>1</sup> / <sub>4</sub> "
Condensate drain (∅ <sub>outer</sub> )	mm	25	25	25	25	25
Electrical supply	V	230	230	230	230	230
Frequency	Hz	50	50	50	50	50
Fuse protection	A	6	6	6	6	6
Maximum power consumption (excl. pump)	W	97	98	123	130	215
Maximum power consumption (incl. pump)	W	190	230	255	325	410
Insulation		IPX4D	IPX4D	IPX4D	IPX4D	IPX4D
Boiler weight, empty, ± 5%	kg	45	55	65	80	90

Table 1 Technical data R30

# Dimensions R30

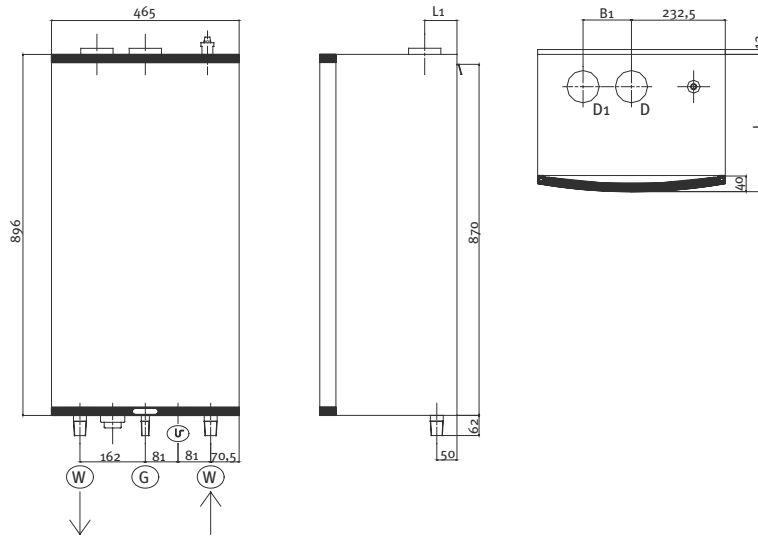

Fig. 1 Dimensions of the R30

Type		R30/45	R30/65	R30/85	R30/100	R30/120
B1	mm	120	120	140	140	140
D	mm	80	80	100	100	100
D1	mm	80	80	100	100	100
G		R 3/4"	R 3/4"	R 3/4"	R 3/4"	R 3/4"
L	mm	340	405	510	560	670
L1	mm	74	90	90	90	90
W		R 1 1/4"/Rp 1"	R 1 1/4"/Rp 1"	R 1 1/4"/Rp 1"	R 1 1/4"/Rp 1"	R 1 1/4"/Rp 1"

Table 2 Dimensions of the R30

(We reserve the right to make changes without prior notification)  
The data may deviate slightly due to fabrication tolerances.

Conditions applicable to table 1:

- Gas consumption at: 1013 mbar, 15°C, dry.
- Gas category: II<sub>2H3P</sub>
- Category of appliance: B23, C13, C33, C43, C53, C63, C83

# 1 Introduction

## 1.1 Stokvis



Since its beginning in 1985, Stokvis has built up a strong reputation in the industry for the development, production and marketing of gas fired, high efficiency boilers and water heaters in the 43-1200kW range.

Thanks to their unique design, these boilers differentiate themselves due to the following:

- High thermal output
- Environmentally friendly (they meet the most stringent environmental requirements)
- Low weight and compact size
- Durability
- Low noise level
- Broad control range
- Available in a wide range of models

Through active, market oriented research, Stokvis is again in a position to offer solutions for the most challenging heating requirements.

## 1.2 The supplier

Stokvis will be happy to provide you with advice or more information concerning our products. You will find our contact details on the cover of this documentation. You can of course always obtain further information via [www.stokvisboilers.com](http://www.stokvisboilers.com).

## 1.3 This document

The present documentation has been prepared with the following target groups in mind:

- The technical consultant
- The installer
- The maintenance technician
- The user

Stokvis has opted to make the technical documentation as comprehensive as possible in the form of this book, in order to ensure that these target groups have all the information they need.

As the supplier we would be happy to help you in connection with any additional information that you may require.

This document covers the following aspects relating to the boilers:

- General description
- Technical specifications
- Requirements for design and installation
- Maintenance instructions

The operating instructions for the user have been affixed to the appliance itself. You will also find them in chapter 6.

## 1.4 Service

The Stokvis Service Department is always ready at hand to commission the appliance and provide maintenance and service. Please refer to the cover for details.

## 1.5 General restrictions

Stokvis products should always be used, installed and maintained in accordance with the statutory requirements, specifications and standards applicable to these installations.

All the data, information and suggestions concerning its products provided by Stokvis are based on careful study.

However, the use, installation and operation of the same are outside the control of Stokvis, and neither Stokvis nor any other organisations associated with it, accept any liability for the same.

**Changes may be incorporated without prior notice. Stokvis accepts no obligation to adapt previously delivered products to incorporate such changes.**

# 2 Description

## 2.1 General

The Rendamax R30 wall mounted boilers are environmentally friendly gas fired heating boilers with a modulation range between approximately 14% and 100% of their maximum output (types 85, 100 and 120: 20% to 100%). The R30 series consists of three models of boiler with an output range of 43 to 120 kW. The appliances have low NO<sub>x</sub> and CO emission, which satisfy the most stringent environmental requirements.



The R30 series has received CE Approval for all relevant European countries and has been registered under the Product Identification Number 0063BO3192.

The boilers may be used on both open (category B23) as well as room sealed (category C13, C33, C43, C53, C63 or C83) systems.

As standard, the boiler is delivered fully wired, fully assembled, and tested.

### **Working principle and design**

Air is drawn in as required, via a speed controlled fan. The zero pressure controller of the gas valve measures the under pressure in the venturi and modulates the gas in response to this pressure from the fan. The gas/air is then thoroughly mixed in the correct ratio and fired directly into the burner.

A temperature controller compares the actual water flow temperature to the desired water temperature. The controller interprets the load required and adjusts the fan speed. The fan sends a speed feed-back signal, and the controller re-adjusts the speed as required.

The mixture of gas and air that is formed is then conveyed through the cylindrical stainless steel burner for combustion.

The heat exchange takes place in a double heat exchanger block. The first heat exchanger is located immediately next to the burner, while the second heat exchanger is connected downstream (condenser). Both heat exchangers consist of several smooth pipes in the form of a coil. The two heat exchangers are connected to each other using water distribution manifolds. The water is circulated by the boiler pump. This pump will be in the boiler for types 45, 65 and 85 and external for the types 100 and 120 (separate delivered).

The R30 boiler has a low water capacity. Due to this, rapid changes of the water temperature can be achieved. It can be used without any return temperature protection. The installed pump provides the water flow rate required. This pump has three-stage modulation (types 45, 65 and 85).



### ***Application possibilities***

The design of the R30 boiler makes it suitable for use in heating systems with:

- constant flow temperature;
- weather dependent set point adjustment;
- low temperature condensing system;
- external temperature control via building optimiser (0 - 5 Vdc = -10°C + 90°C, below 1Vdc the boiler reverts back to the set temperature (P1), see 5.3.2 'connecting terminals')

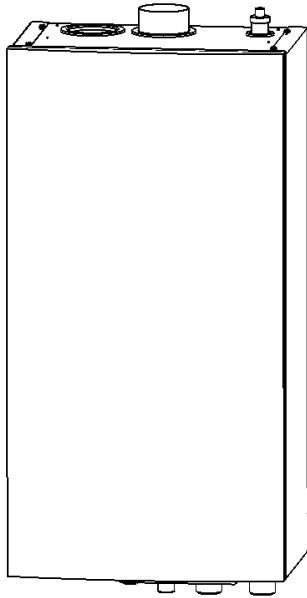

Fig. 2 The Stokvis R30

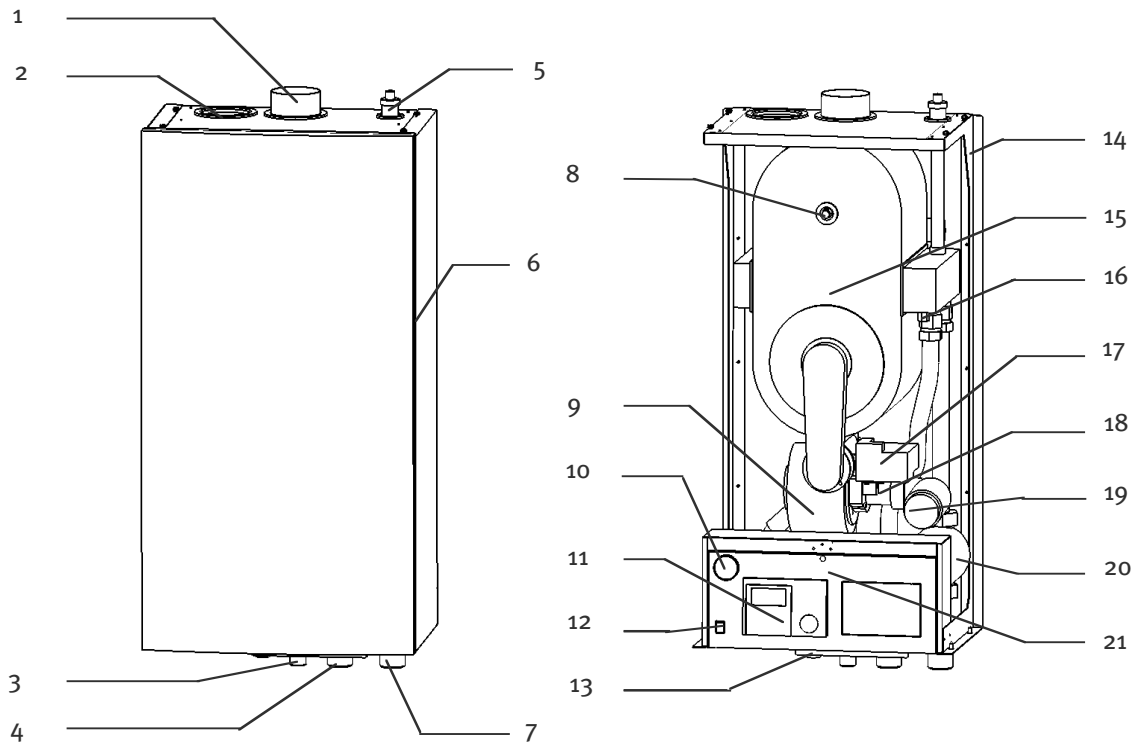

Fig. 3 Overall view

## 2.2 Main components

- |                                |   |
|--------------------------------|---|
| 1 Flue outlet connection       | 12 On/off switch                                      |
| 2 Air inlet connection         | 13 Condensate drain                                   |
| 3 Gas connection               | 14 Frame  |
| 4 Flow connection              | 15 Burner/ heat exchanger package                     |
| 5 Automatic air vent           | 16 Water flow temperature sensor                      |
| 6 Casing                       | 17 Gas valve  |
| 7 Return connection            | 18 Venturi  |
| 8 Flue gas temperature sensor  | 19 Air intake silencer (types 45, 65 and 85)          |
| 9 Fan                          | 20 Boiler pump (types 100 and 120 outside the boiler) |
| 10 Pressure Gauge              | 21 Control panel                                      |
| 11 Automatic boiler controller |   |

### 2.2.1 Description of principal components

The boiler is made of the following components:

#### **Fan [9]**

The fan pulls in and compresses the combustion air, drawn from inside the casing of the boiler. The fan is a DC current fan equipped with a speed feed-back signal. This speed feed-back signal is transmitted back to the controller, which makes the necessary corrections.

#### **Gas train**

The main component of the gas train is the gas valve [17]. The gas quantity is controlled according to the quantity of air. The air quantity varies with the speed of the fan. The gas train is equipped with a test point through which the gas pipe can be vented or the gas inlet pressure can be measured.

### ***Burner/heat exchanger package [15]***

After the gas/air mixture has been correctly mixed, it flows into the burner via the inlet channel. Due to the overpressure, the gas/air mixture is forced through the burner to the external surface of the burner for combustion.

The heat exchanger is made of smooth stainless steel tubes in the form of coils. It essentially consists of two parts; one part is located immediately next to the flame, where the major portion of the heat transfer between the combustion gases and the water takes place. The other part functions as a condenser for the flue gases, where the transfer of latent heat takes place. Stainless steel water distribution manifolds ensure optimum water flow through the heat exchanger.

### ***Water connections***

These consist of a flow connection [4] and a return connection [7]. There is a water temperature sensor [16] on the flow connection which, apart from controlling the burner load, also monitors the water flow in the boiler. The latter is done in combination with the flue gas temperature sensor [8].

### ***Boiler pump [20]***

The boiler pump of the types 45, 65 and 85 is located in the return connection of the boiler and is electrically connected directly to the corresponding terminals in the control panel. The boiler pump of the types 100 and 120 will be delivered separately and can be directly connected to the return connection of the boiler. The capacity and the head of the pump are adequate to overcome not only the boiler resistance but also some system resistance (see table 1). In the types 45, 65 and 85, the pump has three-stage modulation, depending on the load.

### ***Condensate drain [13]***

The boiler is equipped with a bottle trap. This bottle trap is located on the bottom side of the appliance and can be easily filled with water.

### ***Frame [14]***

The frame is the load bearing part of the boiler. All the components are installed on it.

### ***Casing [6]***







The casing can be removed easily as one unit. To do this, unscrew the 8 screws found on the top and the bottom of the casing.

### ***Electrical equipment***

This comprises the control system and safety devices of the boiler. The connection terminals are installed in a fully sealed enclosure behind the control panel [21]. This panel can be tilted through 90° after removing the control panel bolt. This provides access to all the electrical connections, without the need to remove the casing.

## **2.3 Boiler control**

If heat is required, the boiler will start, if all necessary conditions have been fulfilled and no safety devices have been triggered. This heat requirement will arise if:

- The flow temperature of the boiler is less than the required flow temperature
- The manual option has been selected using selector switch set to:  I or  II.
- The frost protection has been triggered independently of the operating conditions (, , ,  I or  II).

The integrated temperature controller adjusts the heat input inside the boiler by changing the fan speed so that the desired temperature is reached and kept at a constant level. Depending on the quantity of air displaced by the fan, a specific quantity of gas will be added. As a result, the boiler capacity can be modulated seamlessly and the heat requirement can be accurately monitored. If the flow temperature rises above the desired level together with any hysteresis, the boiler will switch off. The boiler will start again as soon as the flow temperature falls below the desired level.

## 2.4 Safety aspects

The following safety devices are installed on the boiler:

- Temperature monitoring system
  - High limit temperature monitoring system (STW)
  - Limit temperature monitoring system (STB) (both are adjustable)
- Frost protection system
  - Using an external sensor, if the external temperature falls below 0°C
  - Based on the flow temperature, if this is below 5°C and/or the domestic hot water temperature is below 10°C
- Flame monitoring by means of ionisation measurement
- Fan speed monitoring
- Flue gas temperature monitoring
- Flow monitoring using a combination of flow water temperature and flue gas sensor readings

If one of these safety systems is activated, the boiler will go to an interlocking or lockout fault and will be switched off. Lockout faults can only be reset by pressing the reset button, after rectifying the fault.

# 3 Safety

## **Installation specifications**

Read the specifications before commencing with installation.

The equipment should be installed by a recognised installer in accordance with applicable national and local standards and specifications.

The installation should only be used for heating systems with a maximum water temperature of 90°C.

It is expressly stated that these installation specifications should be regarded as a supplement to the above mentioned standards and specifications, which shall take priority over the information contained in this technical documentation.

## **Icons used**



Instructions that are of essential importance for the correct functioning of the installation.



If the actions, operating procedures, etc. are not followed accurately, this may cause serious damage to the installation, personal injury or damage to the environment.



Danger of electrical shocks.



Useful information.

## **Maintenance**

Work on the electrical installation should only be carried out by a recognised installer in accordance with the applicable electrical regulations.

Work on the gas equipment and hydraulic installation should only be done by personnel having the required training, in accordance with the applicable safety rules and regulations for gas installations.



Keep all unauthorised persons away from the installations.

Do not place any objects on the boiler. Keep a safe distance from the hot water connection and the flue, due to the danger of burns.

Before starting with any maintenance and service work, shut off the electrical supply and close the gas valve to isolate the gas supply.

Check the entire installation for leakages after completing maintenance and service work.



In order to prevent accidents, please refer to the general safety requirements in addition to the information contained in this technical documentation. All parts of the casing should be in place. Casing parts may only be removed for maintenance and service purposes. After carrying out maintenance and service work, replace all the panels.



#### ***Safety devices***

The installation should never be switched on with the casing panels removed or the safety devices disabled.



#### ***Instructions and warning stickers***

Instruction and warning stickers affixed on the appliance should never be removed or covered up, and should be maintained in a legible condition throughout the life of the appliance. Immediately replace damaged or illegible instruction and warning stickers.

#### ***Modification***

The appliance may only be modified with the written permission of the manufacturer.

#### ***Danger of explosion***

While doing work in the boiler room, follow the applicable rules and regulations entitled 'Working in Areas Subject to Danger of Explosion'.

#### ***Installation***

The appliance should be installed by a recognised installer in accordance with applicable national and local standards and specifications.

Follow all the safety instructions precisely.

#### ***Operation***

In case of a gas leakage: switch off the boiler and close the gas valve. Open doors and windows and notify the relevant authorities.

When the appliance is restarted, follow the user instructions.

#### ***Technical specifications***

The specifications contained in this technical documentation should not be exceeded.

## **4 Delivery and transport**

### **4.1 Delivery**

The boiler is delivered fully assembled, tested, and packed.

Check the boiler for damage after receipt.

Check whether the items delivered are correct and in accordance with the items ordered.

#### 4.2 **Packaging**

The boiler is delivered in suitable cardboard packaging.

The types 45, 65, 85 and 100 can be stacked up till two pieces. It's not allowed to stack up the type 120.

#### 4.3 **Transport**



Regarding transportation, refer to the technical data for dimensions and weights.



The packing should only be removed after transportation, or remove the panels before transportation. This is in order to prevent the panels from getting damaged.

#### **Moving**

Each boiler is packed in its own carton which has hand holed at both sides for lifting purposes.

#### **Access requirements**

The dimensions of the boiler are such that all the boiler types can be transported through a door opening of 60 cm.

#### **Mounting**

Install the Stokvis R30 using a spirit level on a sufficiently sturdy wall using the suspension bracket provided. A template has been provided in the packing box, on which the positions of the fixing holes have been indicated.

#### **Protection against frost**

Boilers that are not used during the winter are in danger of freezing. Drain out the water from the filling and drain valve.

## 5 **Installation**

### 5.1 **Regulations**

The appliance should be installed by a recognised installer in accordance with the applicable national and local standards rules and regulations.

The commissioning should preferably be done by the Stokvis Service department to validate the warranty.

### 5.2 **Installation area**

#### 5.2.1 **General**

- Thanks to the design of the boiler, radiation losses are negligible
- Due to the low noise level, there is no need for additional sound insulation of the room
- Due to its compact design, very little installation space is required
- The location options for the boiler are increased because it is supplied suitable for both open and room sealed operation (see chapter 5.3.4).

#### 5.2.2 **Installation**

The following guidelines should be followed in order to optimise the installation of the boilers

- The device should be installed in a frost free room due to the risk of freezing of the condensate drain. The built-in protection system is activated when the temperature of the central heating water falls below 5°C
- Pay attention to the location and temperature sensitivity of the device.

- Ensure that there is sufficient room around the device for maintenance and the replacement of components if necessary

The recommended minimum clearance is as follows:

- 1000 mm to the front (free space for movement);
- 400 mm above;
- 250 mm below;

Since all the components can be accessed from the front, no minimum distance is required on the left and right side. We however recommend a minimum distance of 100 mm in order to enable easy opening of the casing.

### **5.2.3 Ventilation**

The ventilation of the installation room should conform to the applicable national and local standards and regulations.

In connection with ventilation, keep in mind the following points:

- a. Follow the applicable national and local standards and regulations concerning the dimensions of the opening and the protection of the mechanical ventilation system if any
- b. The air inlet openings should be in two walls facing each other
- c. Use broad, low inlet grills
- d. The ventilation outlet should be at high level as high as possible
- e. In the case of insufficient air supply, it may be necessary to mechanically supply ventilation air.

## **5.3 Connections**

### **5.3.1 Gas connection**

The gas connection should be installed by a recognised installer in accordance with applicable national and local standards and specifications.

The gas connection is located on the bottom of the appliance.

The pressure on the inlet side of the appliance should be reduced to 20 mbar for natural gas and up to 50 mbar for propane, using a gas governor.

The pressure loss in the supply pipe should be such that the pressure never falls below 17 mbar for natural gas and 30 mbar for propane, when the appliance is at maximum load.

In order to guarantee that the gas valve works at all times, it is recommended that a gas filter is installed in the gas pipeline. The gas filter can be ordered as an option to be supplied with the boiler.

Install a gas isolating valve directly under the appliance.

### **5.3.2 Electrical connections**

The electrical connections should be installed by a recognised installer in accordance with applicable national and local standards and specifications.

The appliance is fully wired in accordance with the electrical diagrams delivered with the appliance.

All the electrical connections are located behind the control panel. The control panel can be easily opened after removing the locking screw. The cables to be connected (supply, control) enter through the bottom of the appliance via cable glands.

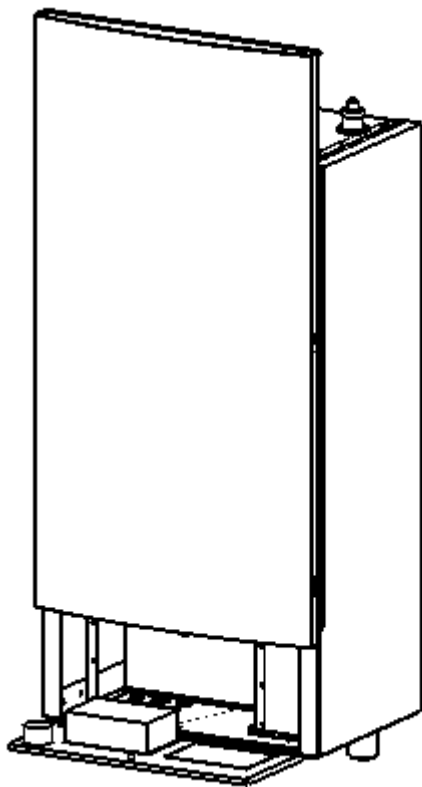

Fig. 4 Connections of the R30

The appliance is suitable for a 230 V 50Hz power supply with live/neutral/earth. Other connecting arrangements are only permissible if an isolating transformer is used. The appliance is phase sensitive. The boiler can be switched on and off using the on/off switch on the control panel.

The installer should use a 2-pole main isolating switch with a contact opening of at least 3 mm in the supply circuit to the boiler. With this, the entire boiler (including the boiler supply pump relay) can be rendered volt free for maintenance work or in the case of failure.

**In order to prevent faults due to electromagnetic fields, a screened cable should be used for the bus connection and for all sensor and control signals between the boiler and all external connection units. The screening should be connected on both sides according to the EMC Directives.**

#### **Controls and options**

The boilers are equipped with a modulating control system. The temperature can be controlled via a 0-5 Vdc signal for example in response to external temperatures. If the voltage falls below 1 volt the boiler reverts to the set point set on parameter P1. A hot water priority circuit also forms part of the standard equipment, an additional sensor is required. Other options available on the boiler can be supplied to extend this. The three following options are:

#### **BME**

A weather-dependent temperature controller with the following features:

- Programming of 3 heating periods with different room temperatures
- Adjustable night time boiler flow temperature reduction operation
- Choice between 2 weekly programmes
- Hot water priority circuit with 2 heat up periods
- Override for single hot water period during night time reduced flow temperature operation
- Optimum start time calculation
- Room temperature control with or without external temperature influence
- Option of internal (standard) or external room sensor (option)



- Adjustable response of the flow temperature to sensed room temperature
- Calibration of the room sensor
- Delay to flow temperature compensation due to external temperature up to a maximum of 3 hours
- Holiday Programme
- Frost protection system based on external temperature or room temperature
- Remote activation via telephone if no external room sensor fitted (external relay required)
- Optimisation of compensation slope based on room temperature and external temperature with optimum start time adjustment
- Hot water Anti-legionella bacteria function (65°C)
- Option of switching off internal room sensor
- 2-wired communication (scom-bus)
- Display in 6 different languages
- External display of KM628 functions with display of status, operating hours, number of starts, degree of modulation and temperatures.

### **E6.1111**

This is a control system for the weather dependent control of two secondary heating circuits. In addition, a hot water circuit can also be controlled at two different Set Points. All the settings can be made separately for each secondary circuit. This E6 controller can be further extended with an optimisation controller system for each secondary group (BM). The weather dependent control of the boiler is done indirectly by the E6.1111.

There are the following additional features to the BME:

- The maximum flow temperature can be set for each heating circuit
- The compensation slope can be manipulated with a parallel displacement to the desired flow temperature of the boiler
- Time controlled hot water re-circulation pump
- Pump-kick function
- DCF receiver for internal clock (optional receiver required)
- Communication over a CAN-bus
- Integrated relay and sensor test
- Can be used in stand-alone operation

### **KKM**

This is a boiler cascade manager with which up to 8 boilers can be connected in cascade and an extra on/off boiler can be operated. The KKM also has the same functional features as the E6.1111.

### **Connecting terminals**

<i>Terminal:</i>	<i>Description:</i>
<b>L1-N-Earth</b>	Supply for the boiler should be installed with 6A fuse protection. If miniature circuit breakers are used, these should have C Rated characteristics.
<b>1-3</b>	Lockout circuit (230 Vac from boiler, 1A). If the connection between the two terminals is broken, the boiler will immediately go into a lockout condition and will remain out of operation until this connection is restored and has been reset using the lockout reset button.
<b>4-5</b>	On/Off. By connecting the two terminals to each other, the boiler is switched from the standby mode to the operating mode and can start when there is a heat requirement. These terminals can be used for thermostatic functions for the boiler. If the circuit is interrupted, the boiler goes into the stand-by mode, except for hot water preparation.
<b>6-7</b>	A hot water temperature sensor can be connected to these terminals. These are recognised automatically by the boiler controller when the supply voltage is switched on. The reading from this sensor is used for controlling the hot water temperature.
<b>8-9</b>	External flow temperature adjustment. A 0-5 Vdc (-10 to+90°C) analogue signal can be applied at these terminals. If the voltage is less than 1 Vdc, it will change over to the internal set flow temperature (set at P1).

<b>10-11</b>	Connection terminals for the 2-wire bus signal (scom-bus). Pay attention to the polarity: namely, terminal 10 is earth and 11 is positive.
<b>ST 1.1-1.2</b>	An OK-signal is available from these terminals (rated at 230 Vac, 1A). This circuit is closed in normal operation and will be open if more than 2 identical faults occur within 6 minutes (the display will show an error code with a “3” appearing above it) or if a fault remains for more than 6 minutes.
<b>ST 2.1-2.2</b>	An outdoor sensor can be connected to these terminals. The automatic control unit of the boiler will automatically detect this connection when the supply voltage is switched on. The reading from this sensor is used for frost protection and for weather-dependent control of the flow temperature of the boiler when fitted with the optional BME, E6.1111, or KKM
<b>ST 9.3-9.4</b>	Interlock circuit (230 Vac from boiler, 1A). If the connection between the two terminals is broken, the boiler will go into a fault condition and remain out of operation until this connection is restored. <b>Attention! If the situation lasts for more than 6 minutes, or if it occurs more than twice within 6 minutes, the boiler will go into a lockout fault and remain out of operation until this connection is restored and is reset using the reset button.</b>
<b>ST 11.1-11.2</b>	Control for the hot water primary pump (230 Vac from boiler, 1A), of which terminal 11.2 is the phase (L) wire and terminal 11.1 is the neutral (N) wire.

### 5.3.3 *Water connections*

It is recommended that the flow and return pipes are securely fixed with brackets. This prevents damage and makes maintenance easier.

The boiler is an instantaneous boiler and is **not suitable for use in open vented systems**. In such cases, a plate heat exchanger should be installed, with which system isolation can be achieved.

The capacity and head of the internal boiler pump is sufficient to overcome not only the boiler resistance but also some system resistance (see table 1).

It is recommended that manually operated valves should be installed between the water connections and the installation.

In order to limit standby losses further, a motorised valve is sometimes installed in the flow or return pipe work, or a mechanical non-return valve may be used for this purpose. Standby losses can be further limited by switching off the boiler via the on/off control circuit.

### 5.3.4 *Flue gas outlet and air inlet*

#### 5.3.4.1 *Connection possibilities*

During installation, a choice can still be made between a ‘room sealed’ and an ‘open’ version. The standard eccentric connection can also be easily changed into a concentric connection.

The flue gas discharge outlet and air intake system should be installed by a recognised installer according to applicable national and local standard and specifications.

- **Type B23:**  
Open type appliance without draught stabiliser, air supply from the room, flue gas discharge outlet above the roof.
- **Type C13:**  
Room Sealed appliance, connected to a concentric air supply / flue discharge through the wall
- **Type C33:**  
Room Sealed appliance, connected to a concentric air supply / flue discharge through the roof
- **Type C43:**  
Room Sealed appliances in cascade, connected to a common concentric air supply / flue discharge at the appliance.

- **Type C53:**  
Room Sealed appliance, connected to a separate air supply and flue discharge pipe, opening into different pressure areas.
- **Type C63:**  
Room Sealed appliance, sold without related connecting and/or discharge fittings
- **Type C83:**  
Room Sealed appliances in cascade, connected to separate air supplies but common flue discharge through the roof.

#### 5.3.4.2 **Air inlet pipe**

The air supply pipe may be single wall, smooth or flexible, and be made of:

- plastic
- aluminium
- stainless steel

Always consider the large resistance when using flexible material.

Always consider condensate formation due to the suction of cold air.

Type	Diameter of air inlet D <sub>1</sub> (mm)
R30/45	80
R30/65	80
R30/85	100
R30/100	100
R30/120	100

Table 3 Diameter of air inlet

The connection for the air supply is on the top of the boiler.

The air supply pipe should be airtight. This is to prevent the suction of 'false air'. Horizontal components in the air supply should be installed sloping in the direction of the supply opening.

#### 5.3.4.3 **Flue gas outlet**

The flue gas components may be single wall, smooth or flexible, and be made of:

- plastic
- aluminium
- stainless steel

Always consider the resistance when using flexible material.

Type	Diameter of air inlet D (mm)
R30/45	80
R30/65	80
R30/85	100
R30/100	100
R30/120	100

Table 4 Diameter of flue gas outlet

The flue gas outlet is located on the top of the appliance and is designed for direct connection to a corrosion resistant flue pipe.

The flue gas discharge pipe to be used should be airtight and watertight at the joints and connections, or should be seamless. Horizontal components in the flue pipe should be installed sloping in the direction of the appliance (minimum 5 cm per meter).

Due to the high efficiency, there may be condensate formation in the chimney even at high water temperatures.



**The condensate drain should never be blocked!**

A direct connection to a brick chimney is not permissible, since the chimney losses must be less than 17%.

The following table gives the flue gas data for all the types

Type	Maximum flue gas temperature at full load	Quantity of flue gas at full load		Maximum permissible flue resistance
	°C	m <sup>3</sup> /h	kg/s	mbar
R30/45	70	74	0.020	1.4
R30/65	70	113	0.031	1.4
R30/85	70	149	0.041	1.4
R30/100	70	168	0.046	1.4
R30/120	70	209	0.058	2.0

Table 5 flue gas data  
 Load 100%  
 Flow temperature 80 °C  
 Return temperature 60 °C

**5.3.4.4 Flue Flue length**

Since the boiler is equipped with a “premix burner” with a fan, an overpressure is created in the boiler. This overpressure is sufficient to overcome the resistance of the burner, the heat exchanger, and the chimney.

The back pressure outside the boiler depends on:

- a. the resistance of the flue pipe
- b. the degree of cooling of the combustion gases
- c. the resistance of the discharge outlet

The degree of cooling of the combustion gases depends on the following:

- a. the insulation value of the flue
- b. the ambient temperature
- c. the flue system and outlet

There is a maximum overpressure of around 1.4 mbar (140 pa) for the types 45, 65, 85, 100 and 2.0 mbar (200 pa) for the type 120 in the boiler for the flue gas discharge system.

**Calculation of diameter and length**

For the calculation and control of the inner diameter of a discharge system with mechanical discharge, please refer to the applicable national and local standards and regulations.

	Length of flue in m					
	Diameter 70 mm	Diameter 80 mm	Diameter 90 mm	Diameter 100 mm	Diameter 110 mm	Diameter 130 mm
R30/45	18	40*	n.a	n.a	n.a	n.a.
R30/65	n.a.	12*	39	67	n.a.	n.a.
R30/85	n.a.	n.a.	18	32*	70	n.a.
R30/100	n.a.	n.a.	n.a.	22*	40	80
R30/120	n.a.	n.a.	n.a.	35*	38	72

Table 6 Length of flue  
The above flue pipe lengths have been rounded down.  
\* Flue diameter on the boiler

These lengths apply to open type appliances.  
For room sealed appliances, these lengths apply to inlets and outlets combined.

Flue losses of various flue components expressed in meters of straight pipe. The total loss should be subtracted from the maximum permissible flue length from the previous table.

Type	Diameter in mm	Pipe bend 90° R/D = 0.5	Pipe bend 90° R/D = 1	Pipe bend 45° R/D = 0.5	T-piece
R30/45	70	3.5	1.4	1.1	4.0
	80*	4.0	1.5	1.2	4.0
R30/65	80*	4.0	1.5	1.2	4.0
	90	4.5	1.7	1.3	4.5
	100	4.9	1.8	1.4	5.4
R30/85	90	4.5	1.7	1.3	4.5
	100*	4.9	1.8	1.4	4.9
	110	5.4	2.0	1.5	5.4
R30/100	100*	4.9	1.8	1.4	4.9
	110	5.4	2.0	1.5	5.4
	130	6.2	2.2	1.6	6.0
R30/120	100*	4.9	1.8	1.4	4.9
	110	5.4	2.0	1.5	5.4
	130	6.2	2.2	1.6	6.0

Table 7 Flue losses in metres of straight pipe  
\* Connection to the appliance

If concentric discharge from the appliance is used, the following maximum lengths (excluding roof clearance) are permissible:

Type	Diameter in mm	Maximum length of straight pipe in m Number of 90° pipe bends		
		2	4	6
R30/45	80/80 - 80/125	17	14	12
R30/65	80/80 - 80/125	4	3	1
R30/85	100/100 - 100/150	16	14	13
R30/100	100/100 - 100/150	9	7	5
R30/120	100/100 - 100/150	10	8	6

Table 8 Maximum length of straight pipe

### 5.3.5 Condensate drain



Condensate water is formed due to the condensation of flue gases, and this has to be drained from the boiler. Pipe the condensate water directly into the waste water drain system. If there is no direct connection to the drain system, a water collection tank equipped with pump and level switch may be used to pump the condensate water into the drain system. In view of the acidity, only plastic drainpipes should be used. Fill the bottle trap with water after installation; the bottle trap beaker on the bottom of the boiler can be easily removed to do so. Ensure that there is an open connection between the drain system and the boiler bottle trap. It is not permissible for condensate to be drained into guttering, since the condensate may freeze.

## 5.4 Hydraulic system

### 5.4.1 Water flow

#### 5.4.4.1 Flow and resistance

The minimum required water circulation over the boiler should be maintained at all times (equivalent to  $\Delta t$  25 K at full load). The minimum required water circulation should not be adversely affected by the use of valves, non-return valves, systems in which several boilers are connected to a common distribution pipe, etc. The maximum water flow is achieved at  $\Delta t$  15 K.

Type	$\Delta t$ 20 K		Pump data				
	Nominal flow rate Q	Boiler resistance nom. flow R	Pump type WILO	Pump speed	Pump head at nom. flow Q	Available head at nom. flow Q	Maximum* Power consumption
	m <sup>3</sup> /h	KPa					
R30/45	1.68	14	RS 25/6-3 PWM/3c	max.	40	26	93
R30/65	2.57	20	RS 25/7-3 PWM/3c	max.	49	29	132
R30/85	3.38	25	RS 25/7-3 PWM/3c	max.	40	15	132
R30/100	3.78	28	TOP-S 30/7	3	52	24	195
R30/120	4.70	30	TOP-S 30/7	3	42	12	195

Table 9 Water flow quantity and pump data for the R30

\* Maximum power consumed is given in pump position 3

When using another  $\Delta t$  you can use the following formula for calculating the flow rate and resistance of the boiler.

#### Flow rate

$$Q = \frac{20}{\Delta T_{\text{new}}} * \text{Nom. flow rate}$$

#### Boiler resistance

$$R = \left( \frac{20}{\Delta T_{\text{new}}} \right)^2 * \text{Boiler res. at nom. flow}$$

After this you have to check the available head of the pump.

The boiler has a pump control circuit. When the boiler is enabled, the pump is switched on. If the boiler is disabled, the pump will continue to run for a few minutes more. This run on time can be adjusted. The standard time is 2 minutes.

### 5.4.1.2 Pump characteristics

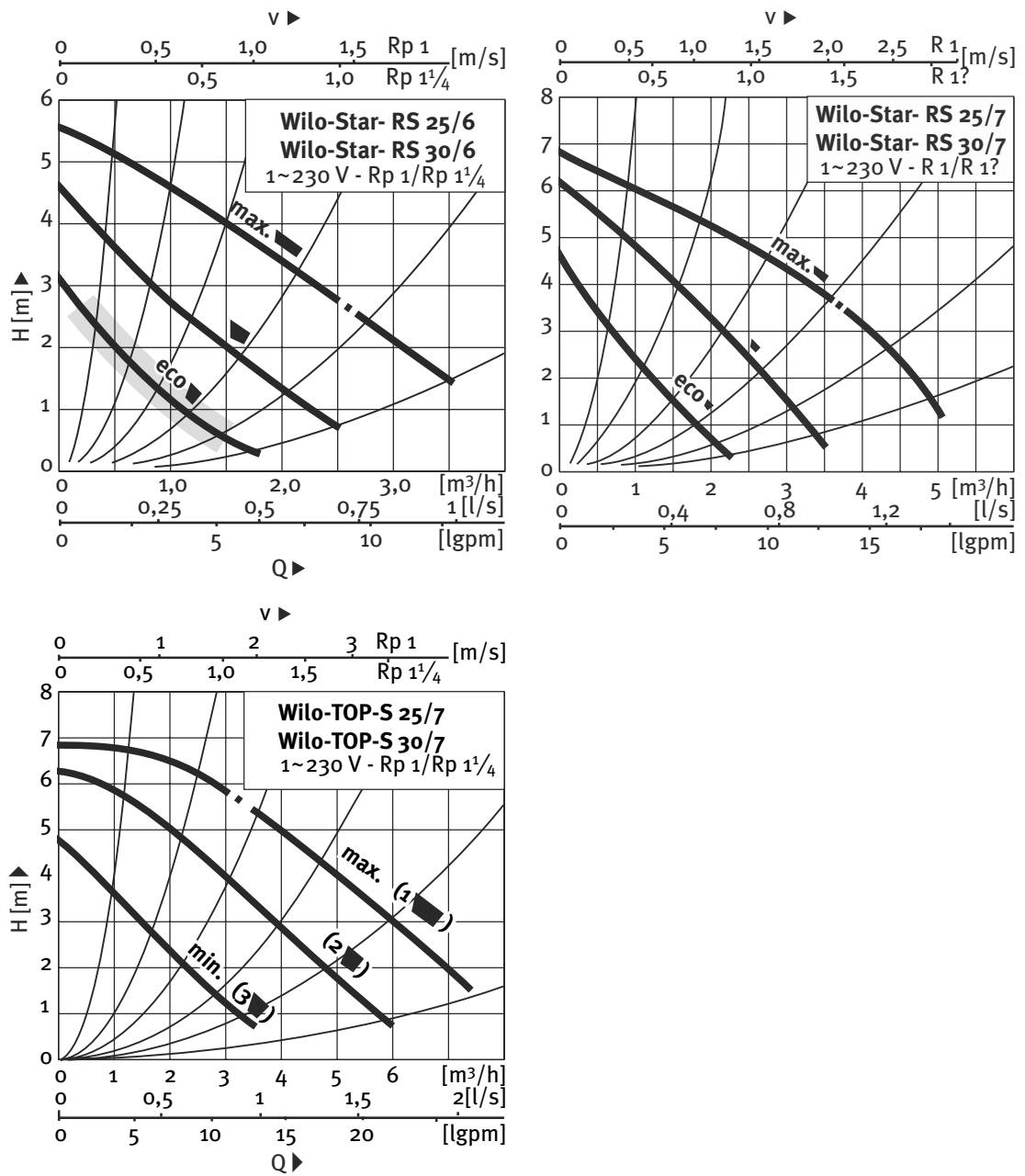

Fig. 5 Pump characteristics

### 5.4.1.3 Shut-off valves

It is recommended that manual valves should be installed between the flow and return connections to the installation.

### 5.4.1.4 Valves

It is possible to install mechanical non-return valves. These valves are intended to prevent water-side short circuiting over the switched-off boiler.

### 5.4.1.5 Water flow protection device

The boiler is equipped with a water flow protection device.

The flow sensor and the flue gas sensor ensure that the protection device gets triggered if the water flow is too low.

## 5.4.2 Water pressure

### 5.4.2.1 Operating pressure

At a maximum flow temperature of 90°C and with the minimum water flow that occurs at a  $\Delta t$  of 20K, the minimum operating pressure should be at least 1.5 bar. The operating pressure should be measured when the pump is switched off. If a lower operating pressure is required, it is necessary to adjust the maximum flow temperature.

Minimum operating pressure in bar	Flow temperature in °C
>1.5	90
>1	80

Table 12 Minimum operating pressures at a rated volume flow of Q

### 5.4.2.2 Boiler expansion vessel

It is recommended that a boiler expansion vessel is installed in the return pipe work between the pump and the boiler shut off valves.

### 5.4.2.3 System expansion vessel

The size of the expansion vessel is determined by the water volume of the system. We recommend that the system expansion tank is placed in the zero point of the low loss header.

### 5.4.2.4 Water pressure protection device

Install a pressure relief safety valve within 0.5 m of the appliance in the pipe between the appliance and the shut-off valves if any, in accordance with BS6759. The size of this safety valve should be at least 1/2" but sized in accordance with the kW rating and system pressure.

## 5.4.3 Water temperature

The maximum permissible water flow temperature is 90°C. If the limit thermostat is triggered at 97°C, the boiler will switch off and will automatically restart when the water temperature falls below the limit temperature that has been set. The high limit thermostat is set to 100°C, if activated the boiler will switch off and will not automatically restart when the water temperature falls.

## 5.4.4 Water quality



The composition and quality of the system water has a direct effect on the performance of the system as a whole, and the life of the boiler. Inappropriate addition and use of chemicals, water softeners, oxygen components, de-aerators, aerators, and water filters increase the chance of faults.

Corrosive elements in some additives may corrode the system, giving rise to leakages; undesirable deposits often damage the boiler heat exchangers.

In connection with the hardness of the water, a distinction should be made between the following:

a. Temporary hardness:

This is also termed carbonate hardness. Deposits are formed at higher temperature and can be removed easily.

b. Permanent hardness:

Minerals (for example calcium sulphate) in the water that are deposited due to very high surface temperatures.

The water hardness is generally expressed in terms of "ppm" and is sub-divided into the following:



Very soft	< 50 ppm
Soft	50-160 ppm
Moderately hard	160-250 ppm
Hard and very hard	> 250 ppm



**The system should contain soft to medium hard water, with the water hardness that does not exceed 250 ppm at a flow temperature of 80°C and  $\Delta t$  20 K.**

Before supplying water, the hardness and chloride value of the system water should always be determined.



The chloride value should never exceed 200 mg/l.

If the chloride value does exceed this value, the cause should be determined. Compare the chloride value of the supply water and the central heating system water. If this content is much higher, and if no materials containing chloride have been added, this indicates evaporation. If the chloride content is very high, the water is rendered more aggressive. (Can be caused by, amongst other things improperly regenerated water softener). The system should be flushed clean and filled with low chloride water.

In order to counter unnecessary wear and tear and blockages due to impurities present in the system, we recommend the use of a filter system with a mesh size of 100 microns. Always place this in the return line of the secondary part of the system.

In order to guarantee a properly working system and long life, one should remove suspended and corrosive particles by installing a suitable filter system.

The periodic inspection including the analysis of the system water and the cleaning of the filters should be performed.

If it is intended to add any chemicals (such as inhibitors) to the water, please first contact Stokvis. They can also give you advice concerning filter systems and other requirements. (Water analysis forms can be obtained from your supplier).

## 6 Operating instructions

### 6.1 Operation

The fan, which is modulated by the temperature controller, supplies the combustion air. Due to the resultant under pressure in the venturi, the zero pressure controller in the gas valve mixes in the required quantity of gas. Gas and air are completely mixed in the venturi.

The gas-air mixture is then fired directly in the burner. The fan also removes the combustion gases. The boiler has no lower limit to the return water temperature. If this temperature is low, condensate will be formed, which is removed via the discharge system.

### 6.2 Controls

Depending on the heat requirement of the boiler, the load should be modulated between 14% and 100%. Below 14% load, the boiler operates on/off, based on temperature.

### 6.3 Boiler module KM628

*Lid closed*

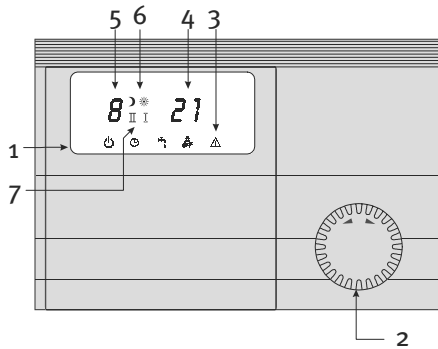

*Lid open*

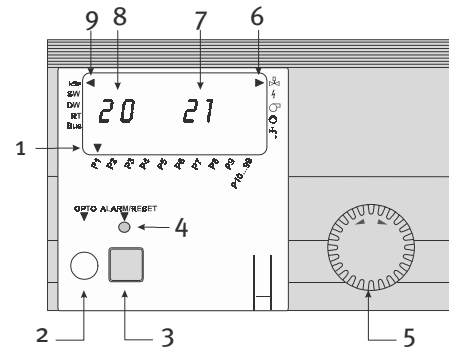

Fig.6 Boiler module

- 1 Operating mode
  - ⏻ Stand-by
  - ⌚ Automatic operation (winter position)
  - ☀ Hot water operation (summer position)
  - ⚙ Service operation (constant load)
- 2 Rotary selection switch: operating mode
- 3 Fault indicator
- 4 Actual flow temperature
- 5 Error code (flashing)
- 6 Operating status
  - ☾ Night / off
  - ☀ Day / on operation
  - ☀ (Flashing) Burner in operation
- 7 Service position
  - ⚙ I Service operation at minimum burner load (P17)
  - ⚙ II Service operation at maximum burner load (P9)

- 1 Parameter indication
    - P1 Actual/required flow temperature
    - P2 Actual/required hot water temperature
    - P3 Required flow temperature\*
    - P5 Actual external temperature
    - P6 Actual flue gas temperature
    - P9 Actual/maximum appliance load
    - P10 Password
  - 2 Optical bus connection for Kesslab
  - 3 Reset/programming push button
  - 4 Alarm/programming LED
  - 5 Rotary selection switch for parameter number selection and required setting adjusting
  - 6 Output status
  - 7 Actual/required parameter value
  - 8 Error code /parameter number
  - 9 Status inputs
- \* Desired load required by the KKM if fitted

#### **Control functions with the lid in the closed position**

With the lid in the close position and by operating the rotary selection switch, the operating mode can be changed to:

- ⏻ Standby (the boiler is out of operation and the frost protection unit is active)
- ⌚ Automatic operation (the boiler is in operation for central heating and hot water production)
- ☀ Hot water operation (the boiler is only in operation for hot water production)
- ⚙ I Service operation (the boiler is operating at constant minimum load set at P17)
- ⚙ II Service operation (the boiler is operating at constant maximum load set at P9)

#### **Information and settings if the lid is opened**

With the lid open and by operating the rotary selection switch, one can access the following 10 parameters. An arrow at the bottom of the display indicates the selected parameter and the actual value of the same is simultaneously displayed.





- P1 Actual/Required flow temperature
- P2 Actual/Required hot water temperature
- P3 Required flow temperature
- P5 Actual external temperature
- P6 Actual flue gas temperature
- P9 Actual/maximum boiler load
- P10 Enter password (only for trained technicians).

### ***Input and output symbols (lid open)***

#### **Input symbols**

-  Ionisation measured for flame detection
- RT** Signal for external enable
- Bus** Signal for bus connection

#### **Output symbols**

-  Control signal to the main gas valves
-  Control signal to the ignition transformer
-  Fan enabled
-  Boiler pump enabled
-  Hot water primary pump enabled

### **Setting the required flow temperature for central heating system operation.**

**Attention! This setting is not active if a KKM, E6.1111 or BME, or an external 0-5 V signal is connected.**

- Open the lid of the KM 628, and a black arrow will appear above P1.
- Press the reset/programming button (item 3); the red LED will light up, then turn the rotary selection switch until the desired temperature appears in the display.
- Again press the reset/programming button: the red LED will go out
- The new flow temperature will now be active
- Close the lid.

### **Set the required hot water temperature for hot water operation.**

**This is only applicable if the hot water mode is being used.**

- Open the lid
- Turn the rotary switch until the arrow at the bottom of the LED displays parameter P2
- Press the reset/programming button (item 3), the LED lights up, then turn the rotary switch (item 5) until the desired hot water temperature appears in the display
- Again press the reset/programming button; the LED will go out
- The new value will now be active
- Close the lid

## **6.4 Fault signals**

In the case of the fault, a flashing  and an error code will constantly appear in the display. In the case of a fault, the cause should first be eliminated before the relevant safeguard is reset. The OK signal will be lost if a fault occurs more than twice within 6 minutes (the error code will be shown in the display with a “3” appearing above it), or in the case of a fault that remains active for more than 6 minutes.

### **1 High Limit thermostat (STB) has been triggered**

If the flow temperature has risen above 100°C the high limit will be activated.

Wait until the flow temperature is below the value set for at least one minute and then reset this safety function by pressing the reset button.

### **2/3 Interlock circuit has been interrupted**

An external safety device connected to the terminals (ST 9.3-9.4) has been triggered. Check and repair this safety device.

### **4 No flame signal when the burner starts**

No flame is detected within the preset safety time when burner starts. Restart is possible if programmed.

### **5 Flame signal lost during operation**

When the burner is in operation, the measured ionisation has fallen below  $1\mu\text{A}$ .

### **6 Limit temperature monitoring system has been triggered**

The flow temperature has risen above the value set for the same, or the water flow is too low.

### **7 The maximum flue gas thermostat has been triggered**

The flue gas temperature has gone above  $100^{\circ}\text{C}$ . Repair the fault and press reset.

### **11 Faulty flame signal**

An ionisation signal of higher than  $1\mu\text{A}$  has been measured while the burner was not in operation. Repair the fault and press reset.

### **12 Defective flow temperature sensor**

The measured resistance value of the flow temperature sensor is outside the range of  $-10$  and  $+126^{\circ}\text{C}$ . Repair the fault and press reset.

### **13 Defective flue gas temperature sensor/lockout input is interrupted**

The resistance value measured by the flue temperature sensor lies outside the range of  $-10$  and  $+126^{\circ}\text{C}$ . Repair the fault and press reset.

An external safety device connected to the terminals (1-3) has been triggered. Check and repair this safety device.

### **14 Defective hot water sensor**

The resistance value measured by the hot water sensor lies outside the range of  $-39$  and  $+110^{\circ}\text{C}$ . Repair the fault and press reset.

### **15 Defective external sensor**

The resistance value measured by the external sensor lies outside the range of  $-39$  and  $+110^{\circ}\text{C}$ . Repair the fault and press reset.

### **20/21 Fault in gas valve control system**

After the burner has been switched off, an ionisation signal of more than  $1\mu\text{A}$  is still measured for 5 seconds. Repair the fault and press reset.

### **24 Faulty minimum fan speed**

During the pre purge, a specific minimum fan speed is not achieved. Repair the fault and press reset.

### **25 Faulty maximum fan speed**

A specific maximum fan speed has been exceeded, thereby failing to meet an ignition prerequisite. Repair the fault and press reset.

### **26 Faulty standby fan speed**

The fan speed is too high (300 rpm) when the fan is switched off. Repair the fault and press reset.

### **30 CRC fault in control system parameters**

An EEPROM fault has arisen in the stored control parameters. Check and change this parameter set.

### **31 CRC fault in safety-relevant parameters**

An EEPROM fault has arisen in the stored safety parameters. Check and change this parameter set.

### **32 Fault in low-voltage supply**

The low voltage supply is too low, or the fuse is defective. Repair the fault and press reset.

### **X.y. Internal fault**

An internal fault has been detected in the electronic system. Check and repair this safety device.

## **6.5 Setting into operation**

- 1 Open the gas valve.
- 2 Switch on the boiler using the on/off switch on the control panel.
- 3 Set the type of operation to “automatic operation ☺” using the “rotary selector switch”. Also see the operating instructions on the boiler.

## **6.6 Switching-off the appliance**

The appliance can be switched off in three ways:

- A The boiler remains available for hot water operation. Using the “rotary selector switch”, set the type of operation to: ☺
- B The boiler is out of operation and only comes into operation due to the automatic frost protection system. Using the “rotary selector switch”, set the type of operation to ☹.
- C Switch off the boiler completely.
  - 1 Switch off the boiler using the on/off switch
  - 2 Close the gas valve.

## **6.7 Warnings**

The appliance should be installed by a recognised installer.  
These operating instructions should be closely followed.

If the cause of the fault cannot be determined, contact the Service department. Never carry out repairs on your own.

The condensate drain outlet should be removed or sealed if a boiler is shutdown during the winter, there is a danger that the condensation may freeze. Drain out the water using the filling and drain valve. The user should not change anything on the appliance or the drain system. Annual inspection and good maintenance are important for guaranteeing optimum performance.

# **7 Commissioning**

## **7.1 General**

The commissioning should only be done by qualified personnel. The guarantee will be void if this is not adhered to.

## 7.2 Commissioning

Before operating the appliance, the following should be done:

- Switch off the electrical power supply of the appliance
- Remove the case. This consists of the double front plate and the side plates.  
Unscrew the 8 screws on the top and bottom. The casing can then be removed in one operation.
- Check the leak-tightness of the gas connection
- Check whether the electrical connection and the earthing have been properly done.  
Also check whether the phase (L) has been connected properly. The boiler is phase sensitive.
- Twist open the cap of the automatic air vent.
- Fill the appliance and the system with water.
- Fill the condensate bottle trap with water. The beaker on the bottom can be easily unscrewed and filled.
- Check the flue gas discharge connection and, if present, the air supply connection.
- Open the gas valve and vent the gas pipe.
- Switch on the electrical power supply of the appliance.
- Check the built in pump.
- Check the boiler at full load.

Start the boiler. Allow the boiler to run at full load and stabilise (around 3 minutes). At full load, the following settings should be checked and corrected if necessary:

### Reference value for full load

Reference value for CO<sub>2</sub>

Types R30/45, R30/65, R30/85 and R30/120	8.8% ± 0.2 for natural gas	G20, G25
	9.8% ± 0.2 for propane	G31
Type R30/100	9.4% ± 0.2 for natural gas	G20, G25
	10.4% ± 0.2 for propane	G31

Reference value for CO

Types R30/45, R30/65 and R30/85	< 50 ppm for natural gas	G20, G25
	< 70 ppm for propane	G31
Types R30/100 and R30/120	< 75 ppm for natural gas	G20, G25
	< 100 ppm for propane	G31

Measure the gas pressure before the gas valve. At full load, this must be at least 17 mbar for natural gas and 30 mbar for propane. If there are several boilers, this pressure should be measured with all the boilers operating at full load.

Check the water-side temperature difference ( $\Delta t$ ) between the flow and return connections of the boiler. The  $\Delta t$  should be between 15 and 25 K at full load.

- Check the boiler at minimum load.  
Set the boiler back to minimum load. At minimum load, the following settings should be checked and corrected if necessary:

### Reference value for minimum load

Reference value for CO<sub>2</sub>

Types R30/45, R30/65, R30/85 and R30/120	8.2% ± 0.2 for natural gas	G20, G25
	9.0% ± 0.2 for propane	G31
Type R30/100	8.8% ± 0.2 for natural gas	G20, G25
	9.6% ± 0.2 for propane	G31

Reference value for CO

Type R30/45	< 5 ppm for natural gas	G20, G25
	< 5 ppm for propane	G31
Types R30/65, R30/85, R30/100 and R30/120	< 10 ppm for natural gas	G20, G25
	< 10 ppm for propane	G31

- Setting the CO<sub>2</sub> value for the R30 series  
There is a flat setting screw on the venturi with which the CO<sub>2</sub> value can be set at full load. Set the boiler at full load and check the CO<sub>2</sub> value.  
If necessary, adjust with the flat setting screw: clockwise gives less CO<sub>2</sub>, anti-clockwise gives more CO<sub>2</sub>.  
There is a torcx setting screw on the gas valve with which the CO<sub>2</sub> value can be set at minimum load. Set the boiler at minimum load and check the CO<sub>2</sub> value. If necessary, readjust with the torcx setting screw: clockwise gives less CO<sub>2</sub>, anti-clockwise gives more CO<sub>2</sub>. After the CO<sub>2</sub> values have been set, they should be checked once again and corrected if necessary.
- Conversion from natural gas to propane.  
For the types R30/45, R30/65, R30/85 and R30/100, a throttle ring will be required for propane. This should be installed between the gas valve and venturi. After the conversion, the CO<sub>2</sub> values should be set at full load and minimum load.  
For the type R30/120 it's only necessary to change the gas volume on the gas valve by using the setting screws.

Type	Diameter of throttle ring
R30/45	6.8 mm
R30/65	6.0 mm
R30/85	6.0 mm
R30/100	6.8 mm

- Remove the measuring equipment and re-fit the case
- The boiler is now ready for operation

## 8 Maintenance

### 8.1 Safety

Wear suitable clothing and shoes for maintenance work. Before you wear jewellery and loose clothing, think of your safety.

### 8.2 General

In order to ensure the proper and safe working of the boiler for a long period of time, it should be inspected at least once a year.

The following operations should be carried out (for a more extensive description of these operations, see 8.3):

- Replace the ignition and ionisation electrodes
- Clean the fan impeller
- Clean the boiler condensate bottle trap and the drain pipe
- Clean the gas filter (if there is one)
- After removing the casing, you can look at the front side with a sight glass at the ignition and combustion (flame picture)
- Test the boiler combustion for CO<sub>2</sub> and CO and if necessary correct the same at minimum load and at full load
- Measure the water temperature difference  $\Delta t$  as a measure of the flow rate
- Check the water pressure
- Inspect the water quality: hardness and chloride contents
- Clean the casing on the outside and ensure that it looks clean again

### **8.3 Procedure**

- a) Switch of the electrical supply to the boiler
- b) Close the gas valve firmly

In order to carry out the following work, it is necessary to first remove the outer casing.

- The ignition and ionisation electrodes are installed on the front side of the boiler. Remove the spark plug caps and inspect the same for possible damage such as signs of arcing and contamination (replace the same if necessary).
- If the boiler is in a dusty environment, the fan impeller may get dirty. This will reduce the air quantity delivered and may unbalance the impeller. Clean the impeller with a brush.
- Clean the condensate bottle trap. The bottle trap beaker can be easily unscrewed from the bottom of the boiler. Clean the same.
- Clean the gas filter (if any). Unscrew the bolts of the gas filter cover. Carefully remove the filter element. Clean the filter by shaking it. In the case of heavy contamination, replace the filter. Install the filter and tighten the cover in place. Check for leakages.
- Check the combustion. Calibrated measuring equipment should be used to carry out gas, air and flue gas measurements.

### **8.4 Cleaning the burner and the heat exchanger**

The burner can be cleaned on both sides with a hard brush after dismantling.

The heat exchanger can be washed clean on the flue gas side. If the heat exchanger is heavily contaminated, (for example soot deposition), the heat exchanger may be cleaned with a brush and water.

The heat exchanger can be cleaned on the water side using suitable cleaning media. For advice concerning the media that are suitable, contact the Service department of your supplier.

### **8.5 Cleaning the strainer of the gas combination block**

The strainer in the gas control combination block can be cleaned. First dismantle the gas valve.

### **8.6 Ionisation measurement**

For carrying out an ionisation measurement, a micro-ammeter with a measuring range of 0-200  $\mu$ ADC should be fitted in the ionisation circuit. The ionisation protection can be checked in this manner. The rated ionisation signal is from 6 to 25  $\mu$ A. The minimum ionisation signal is 2.8  $\mu$ A.

### **8.7 Service**

The Stokvis Service department is always available to provide you with service and maintenance.



## 9 Conversion formulae and factors

### Formulae

$$\text{CO}_2 = \frac{20.9 - \text{measured O}_2}{20.9} \times 11.7$$

$$\text{O}_2 = 20.9 - \frac{\text{measured CO}_2 \times 20.9}{11.7}$$

11.7% CO<sub>2</sub> is the maximum CO<sub>2</sub> percentage that is generated by stoichiometric burning of G20 natural gas (H-gas).

Excess air N:

$$N = \frac{20.9}{20.9 - \text{measured O}_2} \times 0.914$$

or

$$N = 1 + \left( \frac{11.7}{\text{CO}_2 \text{ measured}} - 1 \right) \times 0.914$$

### Conversion factors

For NO<sub>x</sub> (N=1):

$$1 \text{ ppm} = 2.05 \text{ mg/m}^3 = 1.759 \text{ mg/kWh} = 0.498 \text{ mg/MJ}$$

For CO (N=1):

$$1 \text{ ppm} = 1.24 \text{ mg/m}^3 = 1.064 \text{ mg/kWh} = 0.298 \text{ mg/MJ}$$

*Example:*

Measured values for an environmentally friendly unit:

NO<sub>x</sub> = 15 ppm

CO<sub>2</sub> = 10%

What is the value for NO<sub>x</sub> according to the most usual standard in mg/kWh for N=1?

$$\text{O}_2 = 20.9 - \frac{10 \times 20.9}{11.7} = 3\%$$

$$N = \frac{20.9}{20.9 - 3} = 1.17$$

NO<sub>x</sub> (for N = 1) =

$$15.0 \times 1.17 = 17.6 \text{ ppm}$$

$$17.6 \times 1.759 = 30.9 \text{ mg/kWh}$$

W	Kcal/h	Btu/h
1	0.86	3.41
1.163	1	3.97
0.293	0.252	1

Table 13 Conversion factors

1 kcal = 4.187 kJ  
 1 kWh = 3.6 MJ

**Efficiency at the flue gas side**

The difference between gross and nett calorific values is the heat of evaporation of the combustion produced water. At 298.15 K (25°C), this is 2442.5 kJ/kg (583.38 kcal/kg).

**For non-condensating boilers:**

$$\eta_b = 90 - \left( \frac{0.339}{CO_2} + 0.008 \right) \times \Delta T$$

$$\eta_o = 100 - \left( \frac{0.377}{CO_2} \times 0.009 \right) \times \Delta T$$

**For condensating boilers:**

As a result of condensation, the efficiency at the lower value increases.

$$\eta_b = 90 - \left( \frac{0.339}{CO_2} + 0.008 \right) \times \Delta T + A (7.5 + 0.006 \Delta T)$$

$$\eta_o / \eta_b = 1.11$$

- $\Delta t$  = Difference in temperature between the flue gases and the environmental temperature (K)
- $\eta_b$  = Fuel efficiency at the gross calorific value
- $\eta_o$  = Fuel efficiency at the nett calorific value
- $CO_2$  = The volume of  $CO_2$  in the flue gas (%)
- $O_2$  = The volume of  $O_2$  in the flue gas (%)
- $A$  = The quantity of condensed water in the appliance per  $m^3$  gas in kg ( $kg / m^3$  gas).

	meg/l	°dH	°f	°e	Mg CaCO <sub>3</sub> /l
meg/l	1	2.8	5	3.51	50
°dH	0.37	1	1.78	1.25	17.8
°f	0.2	0.56	1	0.7	10
°e	0.285	0.8	1.43	1	14.3
MgCaCO <sub>3</sub> /l	0.02	0.056	0.1	1.54	1

Table 14 Derivation of degrees of hardness

- 1 degree English hardness (°e) = 65 mg CaCO<sub>3</sub>/imp. gallon
- 1 Grain/US Gallon = 0.958 odH
- 1 milligram equivalent per l (mval/l) = 2.8 odH
- 1 ppm (parts per million) CaCO<sub>3</sub> = 1 mg CaCO<sub>3</sub>/l

**For information:**

The public water supply in general has a pH value of approximately 7-8. The temporary hardness will be 60 to 80% of the total hardness, which can vary considerably from one place to another.



